

SERIAL COMMUNICATION CONVERTERS & ADAPTERS

Instruction Manual



- RS-232 to RS-422/485 Converter
- Isolated RS-232 to RS-422/485 Converter
- USB to RS-232 Converter
- USB to RS-422/485 Converter
- Isolated USB to RS-422/485 Converter
- Trident RS-232 & RS-485 Multi-Input Isolated Adapter Board
- Trident Serial Communication RS-232 Adapter
- Trident Serial Communication RS-422/485 Adapter
- PROVu Serial Communication RS-232 Adapter
- PROVu Serial Communication RS-422/485 Adapter

PRECISION DIGITAL CORPORATION
89 October Hill Road • Holliston MA 01746 USA
Tel (800) 343-1001 • Fax (508) 655-8990



www.predig.com

Disclaimer

The information contained in this document is subject to change without notice. Precision Digital makes no representations or warranties with respect to the contents hereof, and specifically disclaims any implied warranties of merchantability or fitness for a particular purpose.

Registered Trademarks

MeterView[®] and ConsoliDator[®] are registered trademarks of Precision Digital Corporation, Modbus[®] is a registered trademark of Schneider Automation Inc. All other trademarks mentioned in this document are the property of their respective owners.

© 2008 Precision Digital Corporation. All rights reserved.

ORDERING INFORMATION

Model	Description
PDA1200	ProVu Meter Copy Cable, 3' (0.9 m)
PDA1232	ProVu RS-232 Serial Adapter
PDA1485	ProVu RS-422/485 Serial Adapter
PDA7420	Trident Meter Copy Cable, 7' (2.1 m)
PDA7232	Trident RS-232 Serial Adapter, PDA7420 included
PDA7422	Trident RS-422/485 Serial Adapter, PDA7420 included
PDA7485-I	RS-232 to RS-422/485 Isolated Converter
PDA7485-N	RS-232 to RS-422/485 Non-Isolated Converter
PDA7488	Trident RS-232 & RS-485 Isolated Multi-Input Adapter
PDA8232-N	USB to RS-232 Non-Isolated Converter
PDA8485-I	USB to RS-422/485 Isolated Converter
PDA8485-N	USB to RS-422/485 Non-Isolated Converter
MeterView [®]	MeterView [®] Software for Trident Meters FREE Download available at www.predig.com/meterview

SAFETY INFORMATION



CAUTION: Read complete instructions prior to installation and operation of the equipment.



WARNING: Risk of electric shock.



WARNING

Hazardous voltages could exist on serial communication wiring networks. Installation and service should be performed only by trained service personnel.

FREE METERVIEW[®] SOFTWARE



- Program Trident from PC
- Monitor up to 100 Tridents

DOWNLOAD METERVIEW[®] SOFTWARE AT
www.predig.com/meterview

Table of Contents

ORDERING INFORMATION	2
SAFETY INFORMATION	3
SPECIFICATIONS	7
PDA1232 PROVu RS-232 Serial Adapter	7
PDA1485 PROVu RS-422/485 Serial Adapter	7
PDA7232 Trident RS-232 Serial Adapter	7
PDA7422 Trident RS-422/485 Serial Adapter	8
PDA7485 RS-232 to RS-422/485 Converter	8
PDA7488 Trident RS-232 & RS-485 Multi-Input Adapter	9
PDA8232 USB to RS-232 Converter	9
PDA8485 USB to RS-422/485 Converter	10
SERIAL COMMUNICATIONS OVERVIEW	11
PDA1232 PROVu RS-232 SERIAL ADAPTER	13
Description	13
Installation	14
Connections	15
PROVu Serial Communication Address (5Er iRL)	15
PDA1485 PROVu RS-422/485 SERIAL ADAPTER	16
Description	16
Installation	17
PROVu Serial Communication Address (5Er iRL)	17
Connections	20
PDA7232 TRIDENT RS-232 SERIAL ADAPTER	21
Description	21
Installation	22
Connections	23
PD765 Serial Communication Address (5ErL)	23
PDA7422 TRIDENT RS-422/485 SERIAL ADAPTER	24
Description	24
Installation	25
PD765 Serial Communication Address (5ErL)	25
Connections	28
PDA7485 RS-232 TO RS-422/485 CONVERTER	29

Serial Communication Converters & Adapters Instruction Manual

Description	29
Installation	30
Connections.....	32
PDA7488 TRIDENT RS-232 & RS-485 MULTI-INPUT ADAPTER	33
Description	33
Installation	34
Mounting.....	34
PD765 Serial Communication Address (5ErL).....	34
Connections.....	36
PDA8232 USB TO RS-232 CONVERTER	37
Description	37
Installation	38
PDA8485 USB TO RS-422/485 CONVERTER	39
Description	39
Installation	40
Connections.....	41
TROUBLESHOOTING	43

Table of Figures

Figure 1. General Four-Wire Network Connection	12
Figure 2. General Two-Wire Network Connection	12
Figure 3. RS-232 Adapter Connections	14
Figure 4. RS-422 or RS-485 Wiring	18
Figure 5. RS-485 Two-Wire Multi-Drop Wiring	19
Figure 6. Connections for PDA1485 to Serial Converter.....	20
Figure 7. RS-232 Adapter Connections	22
Figure 8. Standard Modular Cable Wiring	23
Figure 9. RS-422 or RS-485 Wiring	26
Figure 10. RS-485 Two-Wire Multi-Drop Wiring	27
Figure 11. Standard Modular Cable Wiring	28
Figure 12. Connections for PDA7422 to Serial Converter.....	28
Figure 13. PDA7485 Terminal Connectors and DIP Switch	30
Figure 14. PDA7485 DIP Switch Settings	30
Figure 15. RS-485 Two-Wire Multi-Drop Wiring	31
Figure 16. Connections for PDA7485 in a Four-Wire Network	32
Figure 17. Connections for PDA7485 in a Two-Wire Network	32
Figure 18. PDA7488 Mounting	34
Figure 19. RS-422 or RS-485 Wiring	35
Figure 20. Standard Modular Cable Wiring	36
Figure 21. Connections for PDA8232 to serial device.....	38
Figure 22. PDA8485 DIP Switch Location.....	40
Figure 23. PDA8485 DIP Switch Settings	40
Figure 24. Connections for PDA8485 in a Four-Wire Network	41
Figure 25. Connections for PDA8485 in a Two-Wire Network	41
Figure 26. RS-485 Two-Wire Multi-Drop Wiring	42

Serial Communication Converters & Adapters Instruction Manual

SPECIFICATIONS

PDA1232 ProVu RS-232 Serial Adapter

COMPATIBILITY	EIA-232
CONNECTORS	PC compatible 9-pin D subminiature connector (DB9) and RJ45 (adapter to meter)
CABLE	6' (1.8 m) standard Cat5e cable provided with adapter
DISTANCE	Adapter to ProVu meter: 6' (1.8 m) max; Adapter to computer: 50' (15 m) max; serial interface cable not provided
POWER	Powered by ProVu meter M-Link connection
STATUS INDICATION	Separate LEDs for Power (P), Transmit (TX), and Receive (RX)

PDA1485 ProVu RS-422/485 Serial Adapter

COMPATIBILITY	EIA-422 and EIA-485
CONNECTORS	Removable screw terminal connector and RJ11 (adapter to meter)
CABLE	6' (1.8 m) standard Cat5e cable provided with adapter
DISTANCE	Adapter to ProVu meter: 6' (1.8 m) max; Adapter to computer: 3,937' (1,200 m) max
POWER	Powered by ProVu meter M-Link connection
STATUS INDICATION	Separate LEDs for Power (P), Transmit (TX), and Receive (RX)

PDA7232 Trident RS-232 Serial Adapter

COMPATIBILITY	EIA-232
CONNECTORS	PC compatible 9-pin D subminiature connector (DB9) and RJ11 (adapter to meter)
CABLE	7' (2.1 m) standard modular cable provided with adapter
DISTANCE	Adapter to PD765 meter: 7' (2.1 m) max; Adapter to computer: 50' (15 m) max; serial interface cable not provided
POWER	Powered by Trident PD765 RJ11 connection
STATUS INDICATION	Separate LEDs for Power (P), Transmit (TX), and Receive (RX)

PDA7422 Trident RS-422/485 Serial Adapter

COMPATIBILITY	EIA-422 and EIA-485
CONNECTORS	Removable screw terminal connector and RJ11 (adapter to meter)
CABLE	7' (2.1 m) standard modular cable provided with adapter
DISTANCE	Adapter to PD765 meter: 7' (2.1 m) max; Adapter to computer: 3,937' (1,200 m) max
POWER	Powered by Trident PD765 RJ11 connection
STATUS INDICATION	Separate LEDs for Power (P), Transmit (TX), and Receive (RX)

PDA7485 RS-232 to RS-422/485 Converter

COMPATIBILITY	EIA-232, EIA-422, and EIA-485
CONNECTORS	Screw terminal connector and DB9
DISTANCE	RS-232 connection: 50' (15 m) max; RS-422/485 connection: 3,937' (1,200 m) max
NUMBER OF UNITS	Up to 31 RS-485 compatible devices
POWER	9-12 VDC; 115 VAC/12 VDC adapter included
STATUS INDICATION	Separate LEDs for Power (P), Transmit (TX), and Receive (RX)
ISOLATION	PDA7485-I: 1500 VAC between data lines; 700 VDC input/output-to-power PDA7485-N: 1500 VAC between data lines only

PDA7488 Trident RS-232 & RS-485 Multi-Input Adapter

COMPATIBILITY	EIA-232, EIA-422, and EIA-485
CONNECTORS	Screw terminal connector, RJ11, and DB9
CABLE	Six 3.5' (1 m) standard modular cables provided with adapter
DISTANCE	Adapter board to PD765 meter: 7' (2.1 m) max; RS-232 connection: 50' (15 m) max; RS-422/485 connection: 3,937' (1,200 m) max
NUMBER OF UNITS	Up to 6 Trident meters
POWER	Powered by 1 PD765 RJ11 connection
STATUS INDICIATION	Separate LEDs for power (POWER), transmit (DATA OUT), and receive (DATA IN)
ISOLATION	1500 VAC input-to-output, TX-to-RX line; 500 VAC meter-to-meter
DIMENSIONS	4.0" x 5.5" x 0.9" (H x W x D)

PDA8232 USB to RS-232 Converter

COMPATIBILITY	USB 1.1, USB 2.0, EIA-232
CONNECTORS	PC compatible 9-pin D subminiature connector (DB9) and USB Type A
DRIVERS	Windows [®] 98/2000/ME/XP
DISTANCE	USB connection: 10' (3 m) max; RS-232 connection: 50' (15m) max
POWER	USB port

PDA8485 USB to RS-422/485 Converter

COMPATIBILITY	USB 1.1, USB 2.0, EIA-422, and EIA-485
CONNECTORS	Screw terminal connector and USB Type B
DRIVERS	Windows [®] 98/2000/ME/XP, Linux 2.4 & greater
DISTANCE	USB connection: 10' (3 m) max; RS-422/485 connection: 3,937' (1,200 m) max
NUMBER OF UNITS	Up to 31 RS-485 compatible devices
POWER	USB port
STATUS INDICATION	Separate LEDs for Power (P), Transmit (TX), and Receive (RX)
ISOLATION	PDA8485-I: 1500 VAC between data lines; 700 VDC input/output-to-power PDA8485-N: 1500 VAC between data lines only

SERIAL COMMUNICATIONS OVERVIEW

RS-232, RS-422, and RS-485 are standard interfaces approved by the Electronic Industries Alliance (EIA) for connecting serial devices. In EIA terms, the device (e.g. meter) that connects to the interface is called a Data Communications Equipment (DCE) and the device to which it connects (e.g. the computer) is called a Data Terminal Equipment (DTE).

The RS-422 standard was designed to replace the older RS-232 standard because it supports higher data rates and greater immunity to electrical interference. RS-485 is similar to RS-422 but can support multi-point connections per line because it uses lower-impedance drivers and receivers.

Line drivers and receivers are used to exchange data between two or more points (nodes) on a serial communications network. Reliable data communications can be difficult in the presence of induced noise, ground level differences, and other hazards associated with installation of a network. When communicating at high data rates, or over long distances in real world environments, RS-232 is often inadequate. The differential data transmission of RS-422 and RS-485 offers superior performance in most applications. Differential signals can help nullify the effects of ground shifts and induced noise signals that can appear as common mode voltages on a network.

RS-422 was designed for greater distances and higher baud rates than RS-232. In its simplest form, a pair of converters from RS-232 to RS-422 (and back again) can be used to form an "RS-232 extension cord". Data rates of up to 100 kbits/second and distances of 3,937' (1,200 m) can be accommodated with RS-422.

RS-422 devices however cannot be used to construct a true multi-point network. A multi-point network consists of multiple drivers and receivers connected on a single bus, where any point (node) can transmit and/or receive data. RS-485 is an enhanced version of the RS-422 standard, which allows multiple drivers and receivers on the same two-wire or four-wire system. The RS-485 standard specifies up to 32 drivers and 32 receivers on a single bus, but with the introduction of "automatic" repeaters and high-impedance drivers/receivers, this number can be extended to hundreds of points (nodes) on a network.

The cabling used for an RS-422 or RS-485 serial communications network should always be a high quality cable such as Belden 8162 or

Alpha 6203C. A two-wire system requires two twisted pairs, and a four-wire system requires three twisted pairs (the extra twisted pair is needed for the signal ground).

Figure 1 illustrates how to connect a general four-wire network (a four-wire network actually contains 5 wires).

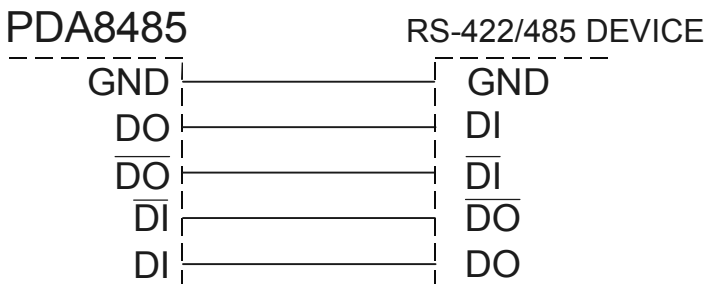

Figure 1. General Four-Wire Network Connection

Figure 2 illustrates how to connect a general two-wire network (a two-wire network actually contains 3 wires). Note that the PDA7485 and PDA8485 have DIP switches that allow for two-wire connections without the need to externally wire the DO to the DI and the $\overline{\text{DO}}$ to the $\overline{\text{DI}}$ (see the converter section for complete details).

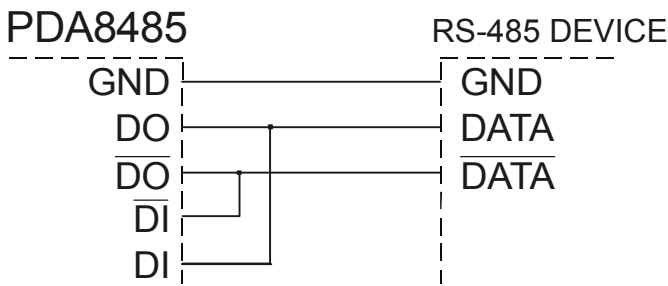
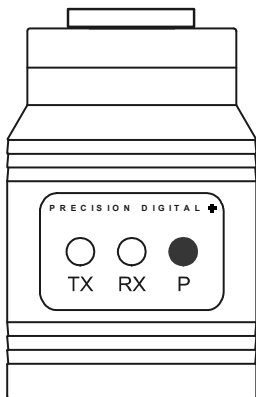

Figure 2. General Two-Wire Network Connection

PDA1232 PROVu RS-232 SERIAL ADAPTER



Description

The PDA1232 converts the serial output of the PROVu meter to an unbalanced, full-duplex RS-232 signal.

The RS-232 port has a female DB9 connector with pins 2 (RX output), 3 (TX input), and 5 (Signal Ground). Pins 7 (RTS) and 8 (CTS) are tied together, and pins 1 (CD), 4 (DTR), and 6 (DSR) are tied together. The adapter is powered by the PROVu meter M-Link connection.

Baud rates are adjustable and handled by the PROVu (see the PROVu Instruction Manual for more details).

The PDA1232 has three diagnostic LEDs: a Power (P) LED to show when the adapter is powered properly, a Transmit Data (TX) LED to show when the adapter is sending data out from the PC side, and a Receive Data (RX) LED to show when the adapter is receiving data from the PROVu meter.

Serial Communication Converters & Adapters Instruction Manual

Installation

Figure 3 shows the connection of a PROVU meter to a PC using the PDA1232 serial adapter. The PDA1232 has an RJ45 connector to connect the Cat5e cable and a PC compatible 9-pin D subminiature connector (DB9). The DB9 can be connected directly to the PC or by using a standard serial extension cable.

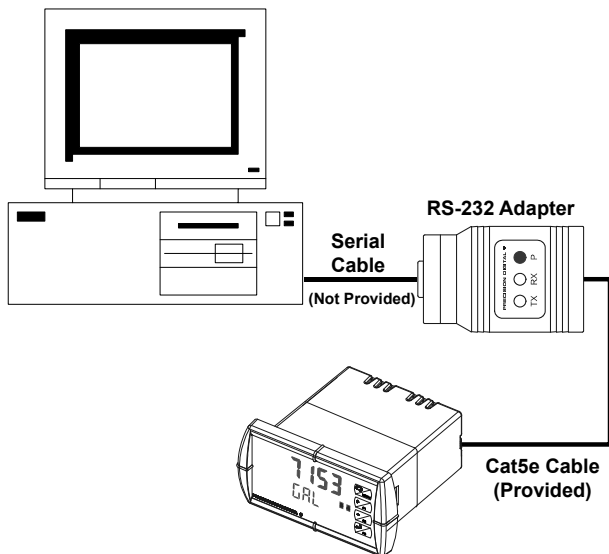

Figure 3. RS-232 Adapter Connections

A Cat5e cable is provided to connect the PROVu meter to the PDA1232 serial adapter.

PROVu Serial Communication Address (SER ,RL)

For the PROVu Trident meter the address may be programmed from 001 to 247. The PROVu meter is factory set to address 001.

To change the PROVu meter address:

1. Press and hold the **Menu** button for three seconds to access Advanced Features menu of the meter.
2. Press **Up** arrow until Serial (SER ,RL) menu is displayed and press **Enter**, Addr E5 is displayed.
3. Press **Enter** to change meter address using **Right** and **Up** arrow buttons. Press **Enter** to accept.
4. Press **Menu** button to exit and return to Run Mode.

PDA1485 PROVu RS-422/485 SERIAL ADAPTER

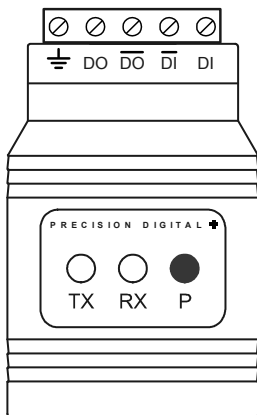

Description

The PDA1485 converts the serial output of the PROVu meter to balanced, full or half-duplex RS-422 or RS-485 signals.

The PD1485 has a removable screw terminal connector for the RS-422/485 terminals which includes Transmit Data (DO) and (/DO), Receive Data (DI) and (/DI), and Signal Ground. The adapter is provided by the PROVu meter M-Link connection.

Baud rates are adjustable and handled by the PROVu (see the PROVu Instruction Manual for more details).

The PDA1485 has three diagnostic LEDs: a Power (P) LED to show when the adapter is powered properly, a Transmit Data (TX) LED to show when the adapter is sending data out from the PC side, and a Receive Data (RX) LED to show when the adapter is receiving data from the PROVu meter.

Installation

Figure 4 shows the connection of a PROVu meter to a PC using the PDA1485 serial adapter and a PDA7485 RS-232 to RS-422/485 converter in an RS-422 network. The PDA1485 has an RJ45 connector to connect the Cat5e cable and a screw terminal connector to connect to the RS-422 network. Figure 5 shows the connection of several PROVu meters with PDA1485 serial adapters to a PC using a PDA7485 RS-232 to RS-422/485 converter in an RS-485 network.

PROVu Serial Communication Address (SERIAL)

When using more than one meter in a multi-drop or multi-point mode, each meter must be provided with its own unique address. For the PROVu meter the address may be programmed from 001 to 247. The PROVu meter is factory set to address 001.

To change the PROVu meter address:

1. Press and hold the **Menu** button for three seconds to access Advanced Features menu of the meter.
2. Press **Up** arrow until Serial (SERIAL) menu is displayed and press **Enter**, ADDR ES is displayed.
3. Press **Enter** to change meter address using **Right** and **Up** arrow buttons. Press **Enter** to accept.
4. Press **Menu** button to exit and return to Run Mode.

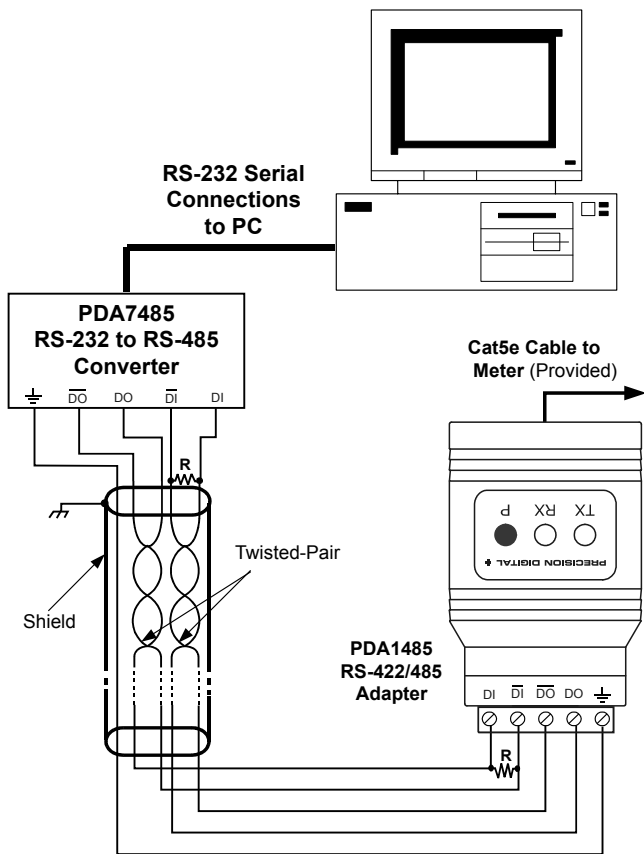

Figure 4. RS-422 or RS-485 Wiring

Notes:

1. Termination resistors are optional and values depend on the cable length and characteristic impedance. Consult the cable manufacturer for recommendations.
2. Refer to RS-232 to RS-422/485 Converter documentation for further details.
3. Use shielded cable, twisted-pairs plus ground. Connect ground shield only at one location.

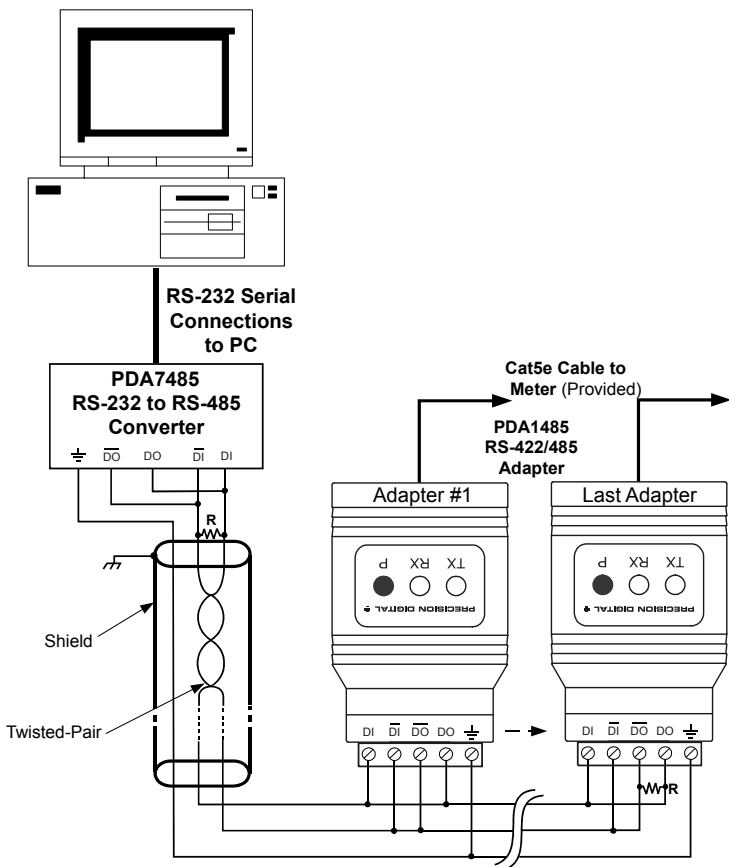

Figure 5. RS-485 Two-Wire Multi-Drop Wiring

Notes:

1. Termination resistors are optional and values depend on the cable length and characteristic impedance. Consult the cable manufacturer for recommendations.
2. Refer to RS-232 to RS-485 Converter documentation for further details.
3. Use shielded cable, twisted-pair plus ground. Connect ground shield only at one location.

Connections

A Cat5e cable is provided to connect the PROVU meter to the PDA1485 adapter.

Figure 6 details the wiring connections from the PDA1485 to an RS-422/485 serial converter (such as the PDA7485 or PDA8485) for a four-wire network.



PDA1485 to RS-422/485 Serial Converter Connections	
RS-422/485 Serial Converter	PDA1485 RS-422/485 Adapter
	
$\overline{\text{DO}}$	$\overline{\text{DI}}$
DO	DI
$\overline{\text{DI}}$	$\overline{\text{DO}}$
DI	DO

Figure 6. Connections for PDA1485 to Serial Converter

If the serial converter is configured for a two-wire network then the requirement to externally wire the DO to the DI and the /DO to the /DI on the PDA1485 screw terminal connector is needed.

PDA7232 TRIDENT RS-232 SERIAL ADAPTER

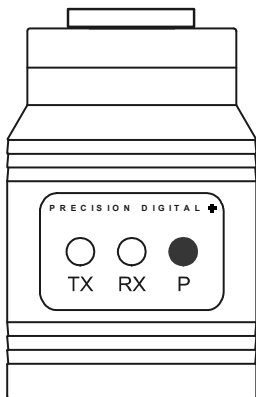

Description

The PDA7232 converts the serial output of the PD765 Trident meter to an unbalanced, full-duplex RS-232 signal.

The RS-232 port has a female DB9 connector with pins 2 (RX output), 3 (TX input), and 5 (Signal Ground). Pins 7 (RTS) and 8 (CTS) are tied together, and pins 1 (CD), 4 (DTR), and 6 (DSR) are tied together. The adapter is powered by the PD765 Trident meter.

Baud rates are adjustable and handled by the PD765 (see the Trident Instruction Manual for more details).

The PDA7232 has three diagnostic LEDs: a Power (P) LED to show when the adapter is powered properly, a Transmit Data (TX) LED to show when the adapter is sending data out from the PC side, and a Receive Data (RX) LED to show when the adapter is receiving data from the Trident PD765 meter.

Serial Communication Converters & Adapters Instruction Manual

Installation

Figure 7 shows the connection of a Trident meter to a PC using the PDA7232 serial adapter. The PDA7232 has an RJ11 connector to connect the PDA7420 modular cable and a PC compatible 9-pin D subminiature connector (DB9). The DB9 can be connected directly to the PC or by using a standard serial extension cable.

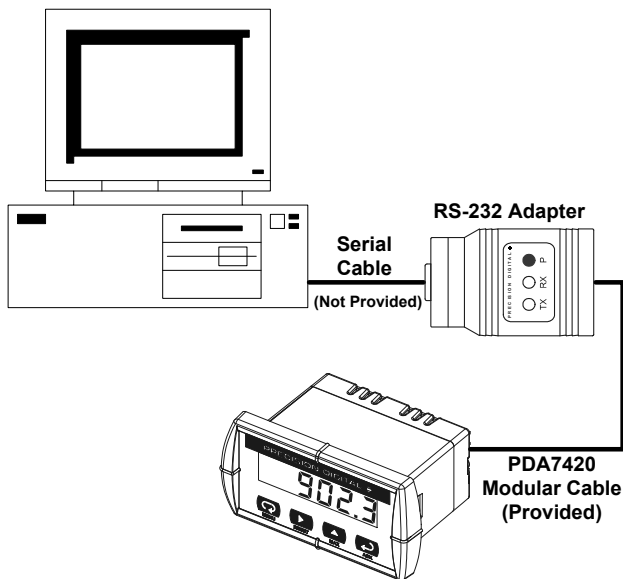

Figure 7. RS-232 Adapter Connections

A PDA7420 cable is provided to connect the Trident meter to the PDA7232 serial adapter. Figure 8 shows the PDA7420 cable details.

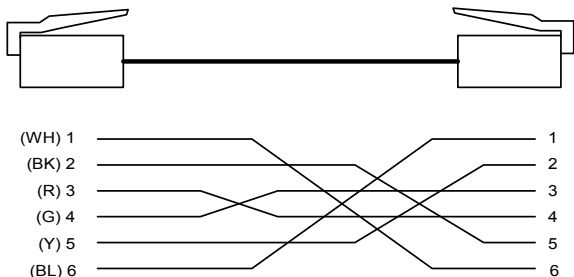

Figure 8. Standard Modular Cable Wiring

PD765 Serial Communication Address (5ErL)

For the PD765 Trident meter the address may be programmed from 00 to 99 for PDC Protocol and from 1 to 247 for Modbus RTU. The PD765 Trident meter is factory set to PDC Protocol at address 00.

To change the PD765 Trident meter address:

1. Press and hold **Right** arrow and **Menu** buttons for three seconds to access Advanced Features menu of the meter.
2. Press **Up** arrow until Serial (5ErL) menu is displayed and press **Enter/Ack**, *Addr* is displayed.
3. Press **Enter/Ack** to change meter address using **Right** and **Up** arrow buttons. Press **Enter/Ack** to accept.
4. Press **Menu** button to exit and return to Run Mode.

PDA7422 TRIDENT RS-422/485 SERIAL ADAPTER

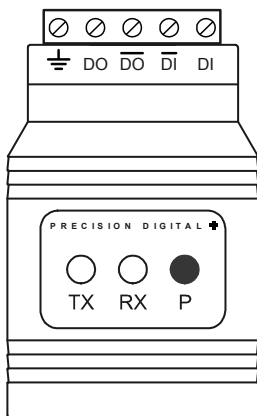

Description

The PDA7422 converts the serial output of the PD765 Trident meter to balanced, full or half-duplex RS-422 or RS-485 signals.

The PD7422 has a removable screw terminal connector for the RS-422/485 terminals which includes Transmit Data (DO) and (/DO), Receive Data (DI) and (/DI), and Signal Ground.

Baud rates are adjustable and handled by the PD765 (see the Trident Instruction Manual for more details).

The PDA7422 has three diagnostic LEDs: a Power (P) LED to show when the adapter is powered properly, a Transmit Data (TX) LED to show when the adapter is sending data out from the PC side, and a Receive Data (RX) LED to show when the adapter is receiving data from the Trident PD765 meter.

Installation

Figure 9 shows the connection of a Trident meter to a PC using the PDA7422 serial adapter and a PDA7485 RS-232 to RS-422/485 converter in an RS-422 network. The PDA7422 has an RJ11 connector to connect the PDA7420 modular cable and a screw terminal connector to connect to the RS-422 network. Figure 10 shows the connection of several Trident meters with PDA7422 serial adapters to a PC using a PDA7485 RS-232 to RS-422/485 converter in an RS-485 network.

PD765 Serial Communication Address (*5ErL*)

When using more than one meter in a multi-drop or multi-point mode, each meter must be provided with its own unique address. For the PD765 Trident meter the address may be programmed from 00 to 99 for PDC Protocol and from 1 to 247 for Modbus RTU. The PD765 Trident meter is factory set to PDC Protocol at address 00.

To change the PD765 Trident meter address:

1. Press and hold **Right** arrow and **Menu** buttons for three seconds to access Advanced Features menu of the meter.
2. Press **Up** arrow until Serial (*5ErL*) menu is displayed and press **Enter/Ack**, *Addr* is displayed.
3. Press **Enter/Ack** to change meter address using **Right** and **Up** arrow buttons. Press **Enter/Ack** to accept.
4. Press **Menu** button to exit and return to Run Mode.

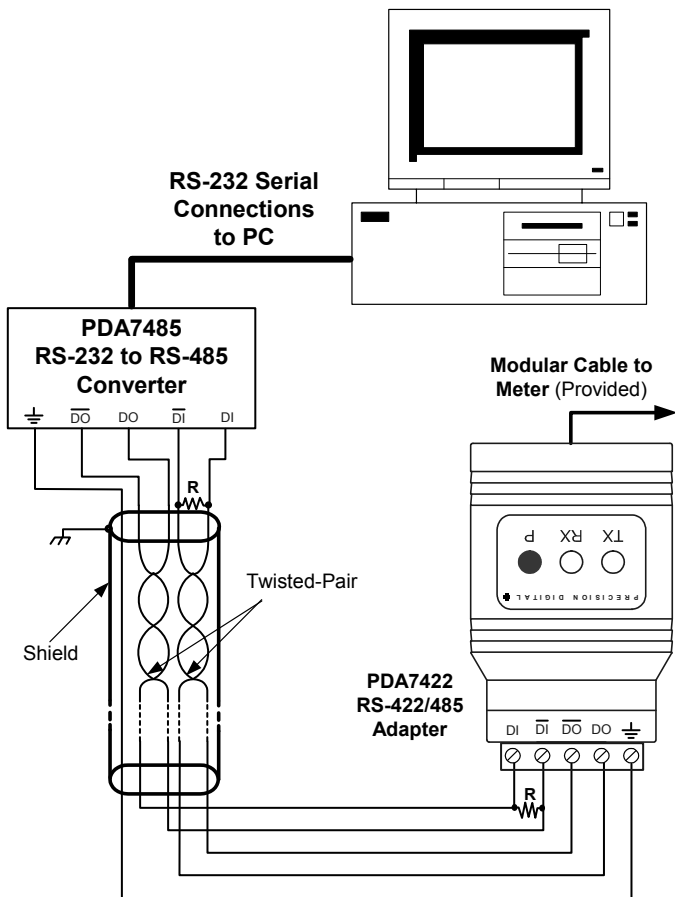

Figure 9. RS-422 or RS-485 Wiring

Notes:

1. Termination resistors are optional and values depend on the cable length and characteristic impedance. Consult the cable manufacturer for recommendations.
2. Refer to RS-232 to RS-422/485 Converter documentation for further details.
3. Use shielded cable, twisted-pairs plus ground. Connect ground shield only at one location.

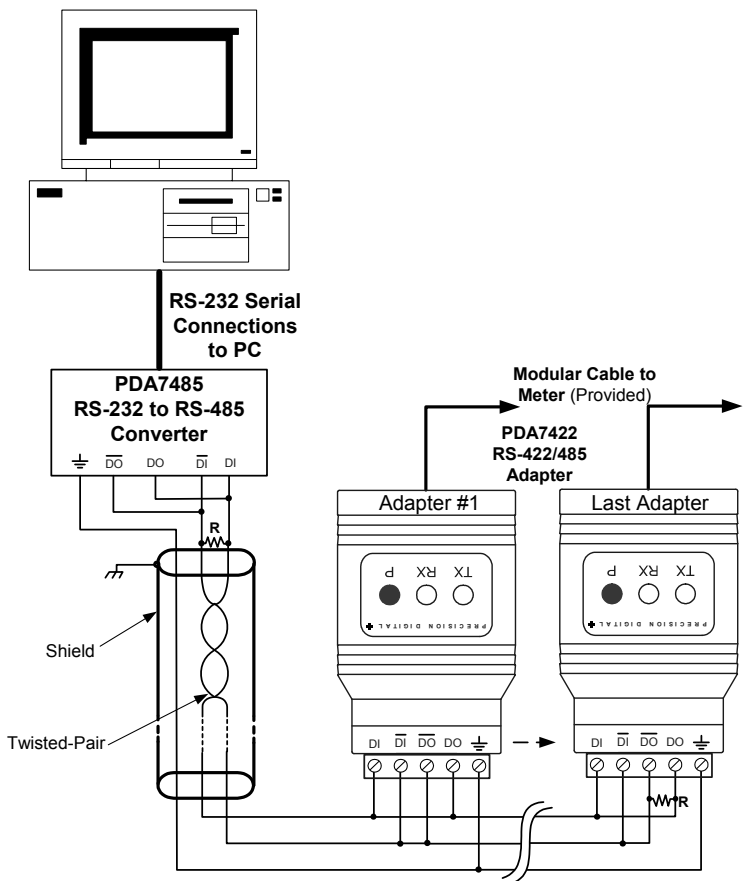

Figure 10. RS-485 Two-Wire Multi-Drop Wiring

Notes:

1. Termination resistors are optional and values depend on the cable length and characteristic impedance. Consult the cable manufacturer for recommendations.
2. Refer to RS-232 to RS-485 Converter documentation for further details.
3. Use shielded cable, twisted-pair plus ground. Connect ground shield only at one location.

Serial Communication Converters & Adapters Instruction Manual

Connections

A PDA7420 cable is provided to connect the Trident meter to the PDA7422 adapter. Figure 11 shows the PDA7420 cable details.

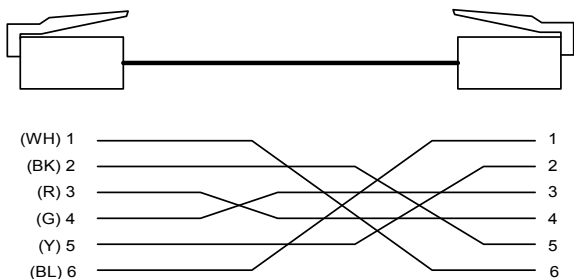

Figure 11. Standard Modular Cable Wiring

Figure 12 details the wiring connections from the PDA7422 to an RS-422/485 serial converter (such as the PDA7485 or PDA8485) for a four-wire network.

PDA7422 to RS-422/485 Serial Converter Connections	
RS-422/485 Serial Converter	PDA7422 RS-422/485 Adapter
$\overline{\text{DO}}$	$\overline{\text{DI}}$
DO	DI
$\overline{\text{DI}}$	$\overline{\text{DO}}$
DI	DO

Figure 12. Connections for PDA7422 to Serial Converter

If the serial converter is configured for a two-wire network then the requirement to externally wire the DO to the DI and the /DO to the /DI on the PDA7422 screw terminal connector is needed.

PDA7485 RS-232 TO RS-422/485 CONVERTER

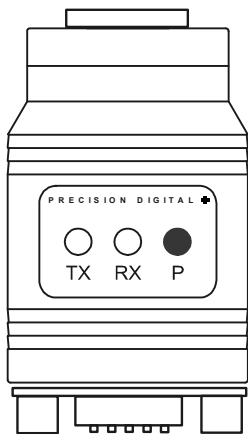

Description

The PDA7485 converts unbalanced, full-duplex RS-232 signals to balanced, full or half-duplex RS-422 or RS-485 signals.

The RS-232 port, configured as a DTE port, has a female DB9 connector with pins 2 (RX output), 3 (TX input), and 5 (Signal Ground). Pins 7 (RTS) and 8 (CTS) are tied together, and pins 1 (CD), 4 (DTR), and 6 (DSR) are tied together. The RS-485 terminal blocks support Transmit Data (DO) and (/DO), Receive Data (DI) and (/DI), and Signal Ground. A separate terminal block supports the power input (+12VDC) and power ground (GND).

Baud rates are automatic and handled by the PDA7485.

The PDA7485 has three diagnostic LEDs: a Power (P) LED to show when the converter is powered properly, a Transmit Data (TX) LED to show when the converter is sending data out from the PC side, and a Receive Data (RX) LED to show when the converter is receiving data from the network side.

The DIP switch SW1 is located between the screw terminal connectors and allows for system configurations.

Installation

The DIP switch SW1 allows for several different options. Factory settings for the switch are shown in Figure 13.

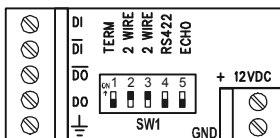

Figure 13. PDA7485 Terminal Connectors and DIP Switch

The TERM switch position adds an internal 120 ohm termination resistor when ON (up). Termination should be used on both ends of the network with high data rates and long wiring runs.

To configure a two-wire network set both of the 2 WIRE switch positions to ON (up). For a four-wire network set both of the 2 WIRE switches to OFF (down).

When the RS422 switch position is ON (up) it is configured for an RS-422 network. For RS-485 networks set the RS422 switch to OFF (down).

The ECHO switch position allows the data being sent from the RS-232 port to be echoed back into the RS-232 port. In most networks, this is an undesired effect and the ECHO switch would be OFF (down).

PDA7485 DIP Switch Settings	
SW1 Switch Position	ON Setting Function
1	Network Termination Included (120 ohm)
2	2-Wire Network Mode Connection (factory setting)
3	2-Wire Network Mode Connection (factory setting)
4	RS-422 Mode
5	ECHO Mode

Figure 14. PDA7485 DIP Switch Settings

Serial Communication Converters & Adapters Instruction Manual

Figure 15 shows an example configuration of a two-wire network. Each device (e.g. Trident PD765 meter) connected to the same network must have a unique address.

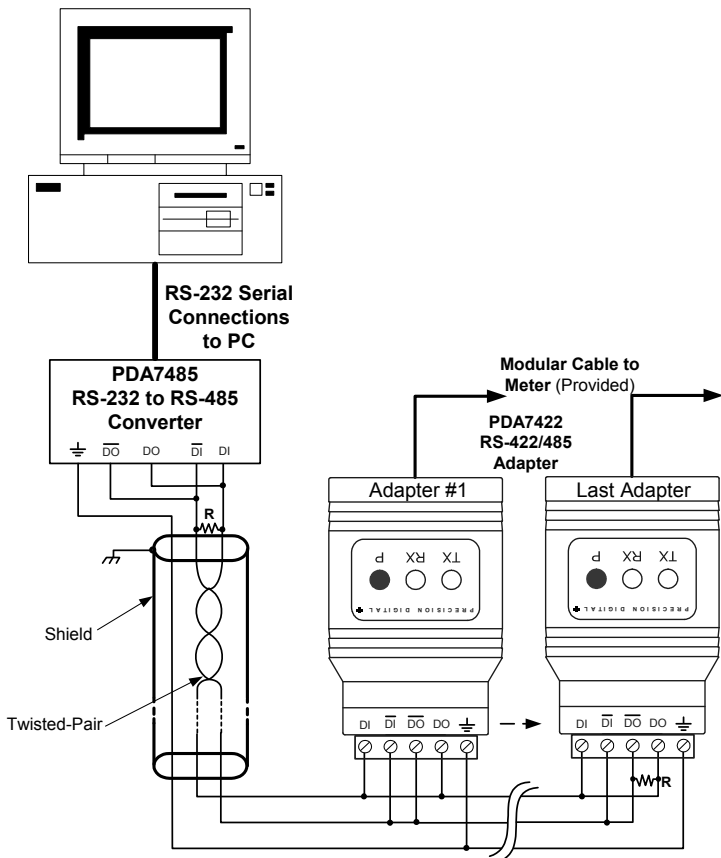

Figure 15. RS-485 Two-Wire Multi-Drop Wiring

Notes:

1. Termination resistors are optional and values depend on the cable length and characteristic impedance. Consult the cable manufacturer for recommendations.
2. Refer to PDA7422 documentation for further details.
3. Use shielded cable, twisted-pair plus ground. Connect ground shield only at one location.

To power the PDA7485, connect 12 VDC to the +12VDC and ground to the GND screw terminals from the supplied 115 VAC/12 VDC adapter.

The PDA7485 may be configured for either a four-wire or two-wire network. Figure 16 details the wiring connections from the PDA7485 to an RS-422/485 serial device in a four-wire network.



PDA7485 to RS-422/485 Serial Device Four-Wire Connections	
PDA7485 Serial Converter	RS-422/485 Serial Device
	
$\overline{\text{DO}}$	$\overline{\text{DI}}$
DO	DI
$\overline{\text{DI}}$	$\overline{\text{DO}}$
DI	DO

Figure 16. Connections for PDA7485 in a Four-Wire Network

Figure 17 details the wiring connections from the PDA7485 to an RS-422/485 serial device in a two-wire network when the DIP switches on the PDA7485 have been set to the “2-Wire Mode”.



PDA7485 to RS-422/485 Serial Device Two-Wire Connections	
PDA7485 Serial Converter	RS-422/485 Serial Device
	
$\overline{\text{DO}}$	$\overline{\text{DATA}}$
DO	DATA

Figure 17. Connections for PDA7485 in a Two-Wire Network

The PDA7485 internally connects the $\overline{\text{DI}}$ to the $\overline{\text{DO}}$ and the DI to the DO when the DIP switches are set to “2-Wire Mode”. Either the $\overline{\text{DI}}$ or $\overline{\text{DO}}$ could be used to connect to $\overline{\text{DATA}}$ and either the DI or DO could be used to connect to DATA.

Two PDA7485 RS-232 to RS-422/485 Serial Converters could be used as a serial extender to allow RS-232 serial devices to communicate over long distances. This would allow an RS-232 device to operate up to 3,937' (1,200 m).

PDA7488 TRIDENT RS-232 & RS-485 MULTI-INPUT ADAPTER

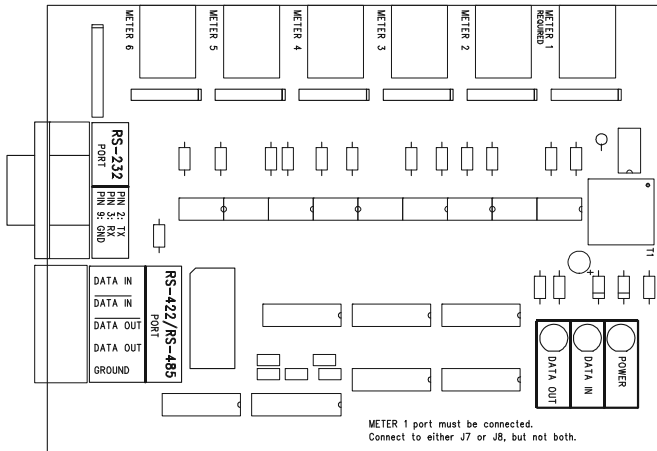

Description

The PDA7488 converts the serial output of the PD765 Trident meter to either an unbalanced, full-duplex RS-232 signal or balanced, full or half-duplex RS-422 or RS-485 signals (but not for use at the same time).

The RS-232 port has a female DB9 connector with pins 2 (RX output), 3 (TX input), and 5 (Signal Ground). Pins 7 (RTS) and 8 (CTS) are tied together, and pins 1 (CD), 4 (DTR), and 6 (DSR) are tied together.

The PDA7488 has a removable screw terminal connector for the RS-422/485 terminals which includes Transmit Data (DO) and (/DO), Receive Data (DI) and (/DI), and Signal Ground.

Baud rates are adjustable (9600 bps and up recommended) and handled by the PD765 (see the Trident Instruction Manual for more details).

The PDA7488 has three diagnostic LEDs: a Power (POWER) LED to show when the adapter is powered properly, a Transmit Data (DATA OUT) LED to show when the adapter is sending data to a PC, and a Receive Data (DATA IN) LED to show when the adapter is receiving data from a PC.

Installation

Figure 19 shows the connection of a Trident meter to a PC using the PDA7488 multi-input adapter board and a PDA7485 RS-232 to RS-422/485 converter in an RS-485 network.

Mounting

The PDA7488 is installed using the four adhesive-backed mounting feet included. Install the mounting feet into the holes on the corner of the board such that the flat adhesive backed side is on the opposite side of the connectors as shown in Figure 18. Clean the mounting surface prior to installation. Remove the adhesive backing liner and press the corners firmly when positioned for final installation (making sure to allow for adequate room for all connections and/or wiring).

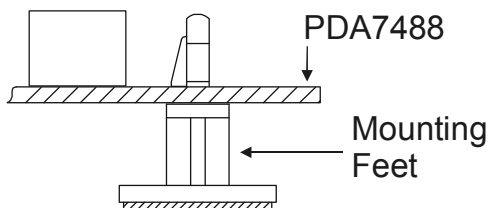

Figure 18. PDA7488 Mounting

PD765 Serial Communication Address (5E_rL)

When using more than one meter in a multi-drop or multi-point mode, each meter must be provided with its own unique address. For the PD765 Trident meter the address may be programmed from 00 to 99 for PDC Protocol and from 1 to 247 for Modbus RTU. The PD765 Trident meter is factory set to PDC Protocol at address 00.

To change the PD765 Trident meter address:

1. Press and hold **Right** arrow and **Menu** buttons for three seconds to access Advanced Features menu of the meter.
2. Press **Up** arrow until Serial (5E_rL) menu is displayed and press **Enter/Ack**, *Addr* is displayed.
3. Press **Enter/Ack** to change meter address using **Right** and **Up** arrow buttons. Press **Enter/Ack** to accept.
4. Press **Menu** button to exit and return to Run Mode.

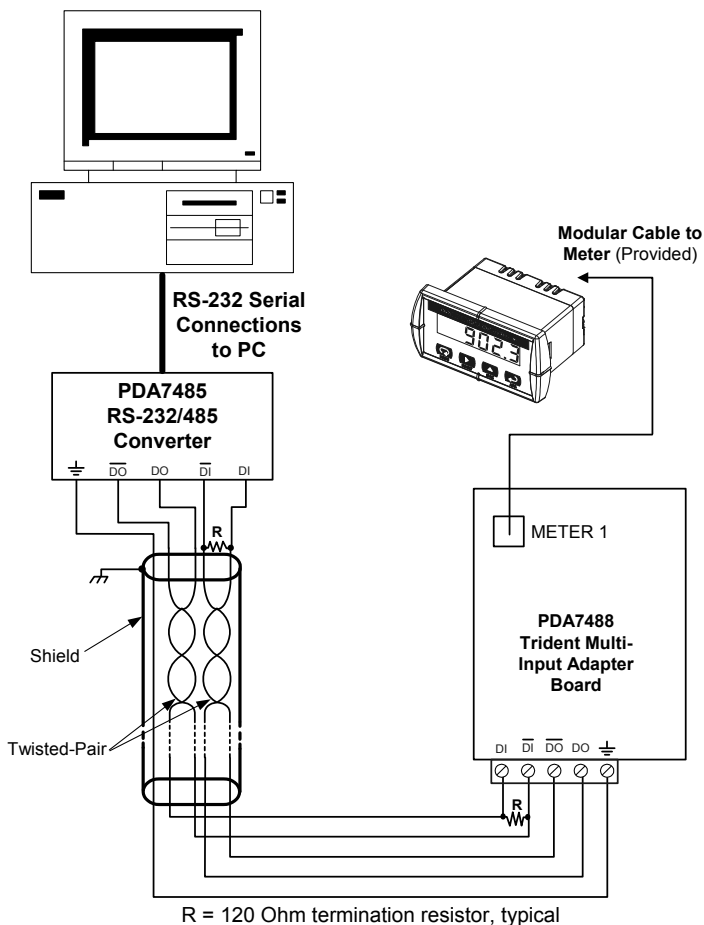

Figure 19. RS-422 or RS-485 Wiring

Notes:

1. Termination resistors are optional and values depend on the cable length and characteristic impedance. Consult the cable manufacturer for recommendations.
2. Refer to RS-232 to RS-422/485 Converter documentation for further details.
3. Use shielded cable, twisted-pairs plus ground. Connect ground shield only at one location.

Serial Communication Converters & Adapters **Instruction Manual**

Connections

The PDA7488 Multi-Input Adapter Board is powered by a Trident PD765 meter connected to METER 1 connector as shown on Figure 19. The attached meter must be powered and the connection using the standard modular cable provided must be maintained to power the adapter. Figure 20 shows the cable details.

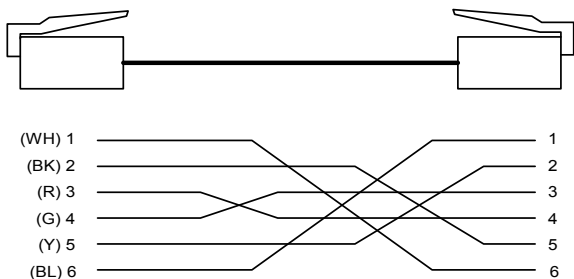
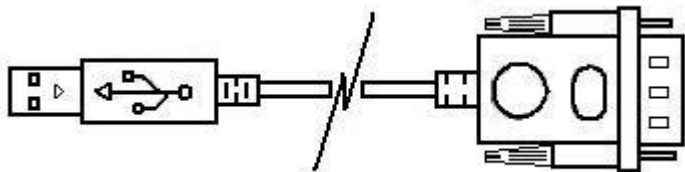

Figure 20. Standard Modular Cable Wiring

PDA8232 USB TO RS-232 CONVERTER



Description

The PDA8232 USB to RS-232 Converter allows for direct connection of a serial device to the USB port of a PC.

Figure 21. shows the connection of a Trident meter to a PC using a PDA8232 USB to RS-232 Converter, PDA7232 RS-232 Adapter, and the PDA7420 Modular Cable.

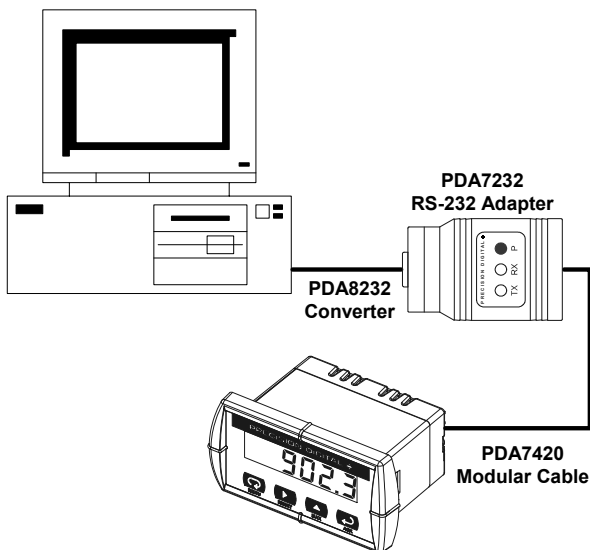
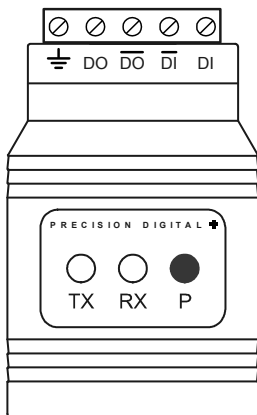

Figure 21. Connections for PDA8232 to serial device

When connecting a Precision Digital ConsoliDator[®] to a PC using the PDA8232 USB to RS-232 Converter, a Null Modem Cable (not included) must be used. A Null Modem Cable is a serial cable that swaps pairs of the wires to allow the two connected devices to operate as they would if they were linked using modems.

Two PDA7485 RS-232 to RS-422/485 Serial Converters could be used as a serial extender to allow RS-232 serial devices to communicate over long distances. This would allow an RS-232 serial device, such as the Precision Digital ConsoliDator[®], to operate up to 3,937' (1,200 m).

PDA8485 USB TO RS-422/485 CONVERTER



Description

The PDA8485 converts USB to balanced, full or half-duplex RS-422 or RS-485 signals.

The PDA8485 has a removable screw terminal connector for the RS-422/485 terminals which includes Transmit Data (DO) and (/DO), Receive Data (DI) and (/DI), and Signal Ground.

Baud rates are automatic and handled by the PDA8485.

The PDA8485 has three diagnostic LEDs: a Power (P) LED to show when the converter is powered properly, a Transmit Data (TX) LED to show when the converter is sending data out from the PC side, and a Receive Data (RX) LED to show when the converter is receiving data from the network side.

The DIP switch SW1 is located inside the case and allows for system configurations.

Installation

The DIP switch SW1 allows for several different options. Factory settings for the switch are shown in Figure 22.

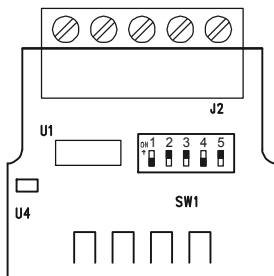

Figure 22. PDA8485 DIP Switch Location

The termination switch position adds an internal 120 ohm termination resistor when ON (up). Termination should be used on both ends of the network with high data rates and long wiring runs.

To configure a two-wire network set both of the 2-wire switch positions to ON (up). For a four-wire network set both of the 2-wire switches to OFF (down).

When the RS-422 switch position is ON (up) and the RS-485 switch position is OFF (down) it is configured for an RS-422 network. When the RS-422 switch position is OFF (down) and the RS-485 switch position is ON (up) it is configured for an RS-485 network.

PDA8485 DIP Switch Settings	
SW1 Switch Position	ON Setting Function
1	Network Termination Included (120 ohm)
2	2-Wire Network Mode Connection (factory setting)
3	2-Wire Network Mode Connection (factory setting)
4	RS-422 Mode
5	RS-485 Mode (factory setting)

Figure 23. PDA8485 DIP Switch Settings

The PDA8485 is powered by the USB port.

The PDA8485 can be configured for either a four-wire or two-wire network. Figure 24 details the wiring connections from the PDA8485 to an RS-422/485 serial device in a four-wire network.



PDA8485 to RS-422/485 Serial Device Four-Wire Connections	
PDA8485 Serial Converter	RS-422/485 Serial Device
	
$\overline{\text{DO}}$	$\overline{\text{DI}}$
DO	DI
$\overline{\text{DI}}$	$\overline{\text{DO}}$
DI	DO

Figure 24. Connections for PDA8485 in a Four-Wire Network

Figure 25 details the wiring connections from the PDA8485 to an RS-422/485 serial device in a two-wire network when the DIP switches on the PDA8485 have been set to the “2-Wire Mode”.



PDA8485 to RS-422/485 Serial Device Two-Wire Connections	
PDA8485 Serial Converter	RS-422/485 Serial Device
	
$\overline{\text{DO}}$	$\overline{\text{DATA}}$
DO	DATA

Figure 25. Connections for PDA8485 in a Two-Wire Network

The PDA8485 internally connects the $\overline{\text{DI}}$ to the $\overline{\text{DO}}$ and the DI to the DO when the DIP switches are set to “2-Wire Mode”. Either the $\overline{\text{DI}}$ or $\overline{\text{DO}}$ could be used to connect to $\overline{\text{DATA}}$ and either the DI or DO could be used to connect to DATA.

TROUBLESHOOTING

Symptom	Check/Action
Power LED is off	PDA1232, PDA1485, PDA7232, or PDA7422: 1. Check modular cable connection 2. Check power to meter PDA7485: 1. Check wall plug adapter output 2. Check power connection polarity PDA7488: 1. Check Meter 1 connected/powering 2. Check modular cable connections PDA8485: 1. Check USB connections 2. Try different USB port 3. Check USB port with other device
Meter not communicating with MeterView [®] or other programs	Check: 1. Serial adapter and cable 2. Serial protocol selected 3. Meter address and baud rate 4. MeterView address and baud rate 5. Check DIP switch setting on the PDA7485 or PDA8485
If only the TX (or DATA IN) data status LED is flashing when serial communications attempted	Check: 1. Serial adapter and cable 2. Serial protocol selected 3. Meter address and baud rate 4. MeterView address and baud rate 5. Check DIP switch setting on the PDA7485 or PDA8485
If both data status LEDs (TX and RX) are off when trying to communicate	Remove all unnecessary cables and meters. Try getting the system to work with only one meter (to ease troubleshooting) and then expand the system one device at a time. PDA1232, PDA7232, or PDA7485: 1. Check serial cable 2. Connect the DB9 directly to the PC 3. Try a different serial port
Communications slow	Increase the baud rate
Random communication errors	1. Increase the TX delay time 2. Decrease the baud rate
Other symptoms not described above	Call Technical Support for assistance.

How to Contact Precision Digital

- For Technical Support please
Call: (800) 610-5239 or (508) 655-7300
Fax: (508) 655-8990
Email: support@predig.com
- For Sales Support or to place an order please
Call: (800) 343-1001 or (508) 655-7300
Fax: (508) 655-8990
Email: sales@predig.com
- For the latest version of this manual please visit
www.predig.com

